

## GENUINE PARTS

### INSTALLATION INSTRUCTIONS

1. **DESCRIPTION:** Side Window Deflector
2. **APPLICATION:** QX80
3. **PART NUMBER:** H0800-1LK00
4. **KIT CONTENTS:**

Item	Qty.	Description	Part Number
A	1	Front Door Side Window Deflector - LH	---
B	1	Front Door Side Window Deflector - RH	---
C	1	Rear Door Side Window Deflector - LH	---
D	1	Rear Door Side Window Deflector - RH	---
E	8	Bracket	---
F	1	Installation Instructions Replacement Template	---

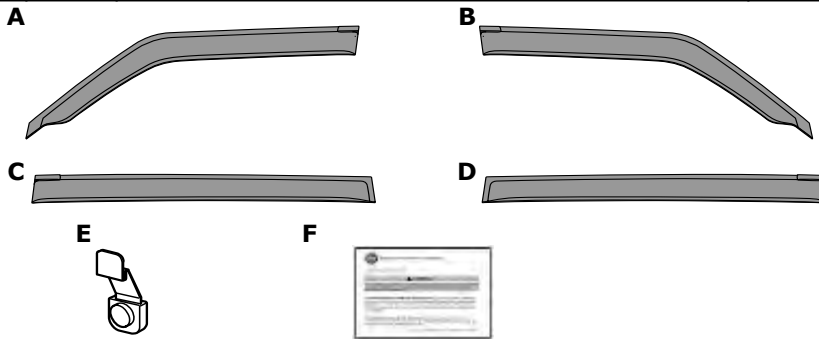

5. **TOOLS REQUIRED:**
  - 100% Alcohol
  - Masking tape
  - Tape measure
  - Clean, lint-free wiping cloth
  - Erasable marker

#### 6. PRE-INSTALLATION CAUTIONS/NOTES:

#### CAUTION

- Install the Side Window Deflector when the ambient temperature is above 60° F (15°C).
- Do not wash or expose the vehicle to a wet environment for 24 hours after installing the Side Window Deflector.

#### NOTE

- These instructions are for the left side of the vehicle; the same procedure applies to the right side.

## INSTALLATION INSTRUCTIONS - Side Window Deflector

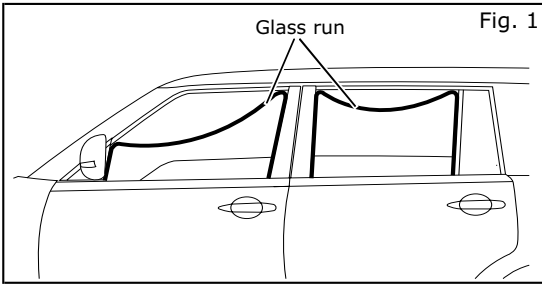

1. Installation preparation
  - a) Open the doors and completely lower all windows.
  - b) Remove the upper portion of the glass run from the door sash by pulling down on the glass run. See Fig. 1.
  - c) Close the doors.

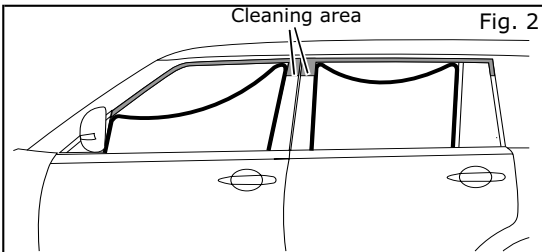

- d) Using a clean, lint free cloth and 100% alcohol, wipe any dirt and oil from the mounting surface. Let area dry thoroughly. See Fig 2.

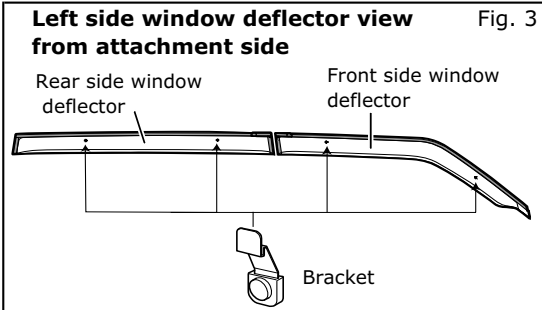

2. Side window deflector installation
  - a) Assemble bracket (supplied) to the front and rear side window deflector by pushing bracket (supplied) firmly against the boss on the backside of the front and rear side window deflector at the marked location. See Fig. 3 and 3-1

**NOTE:**  
**BE SURE THAT THE BRACKETS ARE INSTALLED IN THE RIGHT PLACE AND DIRECTION. ONCE THE BRACKETS ARE INSTALLED, THEY CANNOT BE REMOVED.**

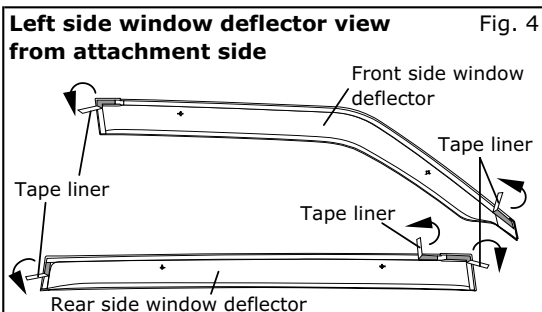
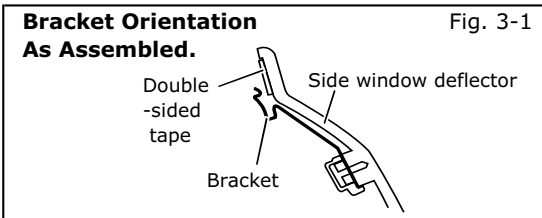

- b) Peel off about 50 mm of the tape liner from the double-sided tape at each pull tab on the front and rear side window deflector.
- c) Fold the tape liner onto the side window deflector front surface and apply masking tape to ensure that the tape liner is accessible. See Fig. 4.

## INSTALLATION INSTRUCTIONS - Side Window Deflector

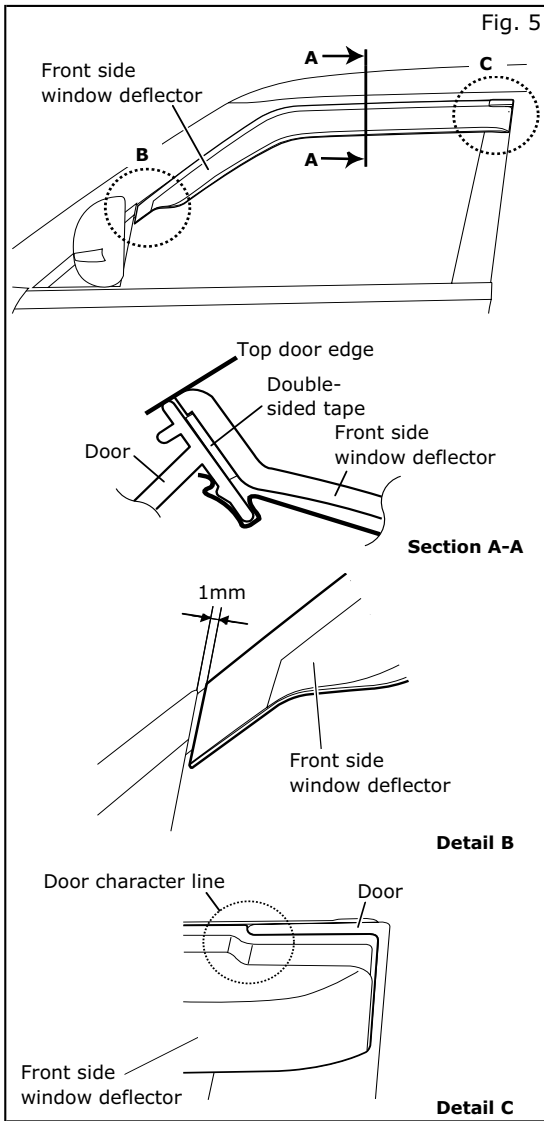

- d) Align the front side window deflector to the top door edge (Section A-A), mirror base (Detail B), and door character line (Detail C). See Fig. 5.
- e) Attach the front side window deflector brackets to the door frame and lightly push the front side window deflector against the door.

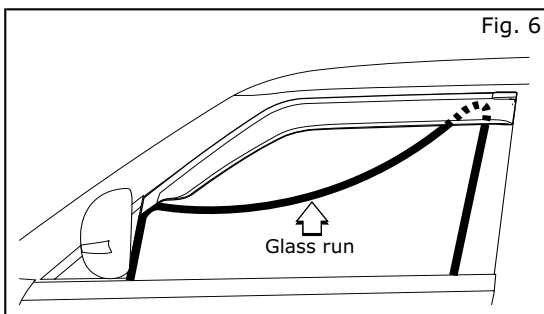

- f) Install the glassrun to temporarily secure the front side window deflector in place. See Fig. 6.
- g) Adjust the front side window deflector to align to the top door edge, mirror base, and door character line.

## INSTALLATION INSTRUCTIONS - Side Window Deflector

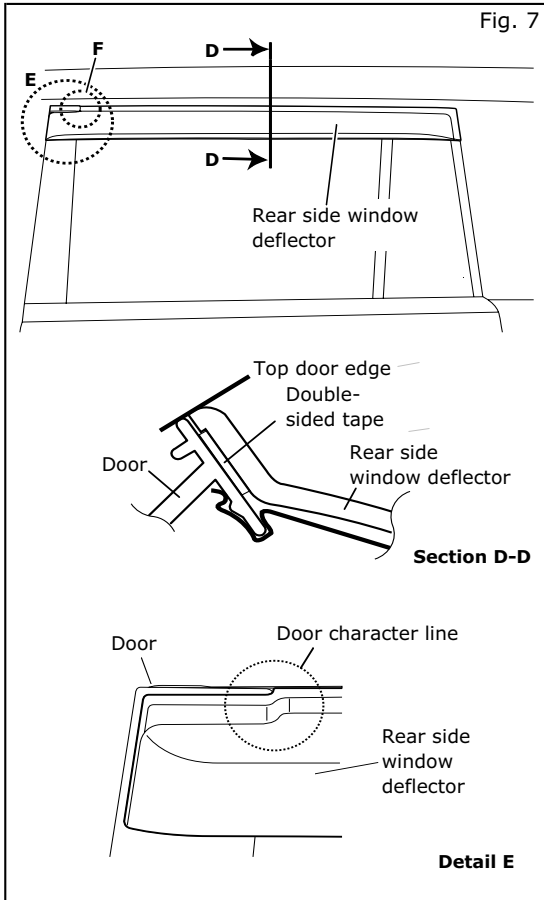

- h) Align the rear side window deflector to the top door edge (Section D-D), and door character line (Detail E). See Fig. 7.
- i) Attach the rear side window deflector brackets to the door frame and lightly push the rear side window deflector against the door.

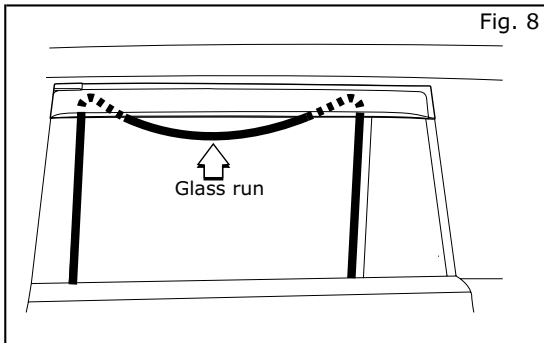

- j) Install the glass run to temporarily secure the rear side window deflector in place. See Fig. 8.
- k) Adjust the rear side window deflector to align to the top door edge, measure, and door character line.

## INSTALLATION INSTRUCTIONS - Side Window Deflector

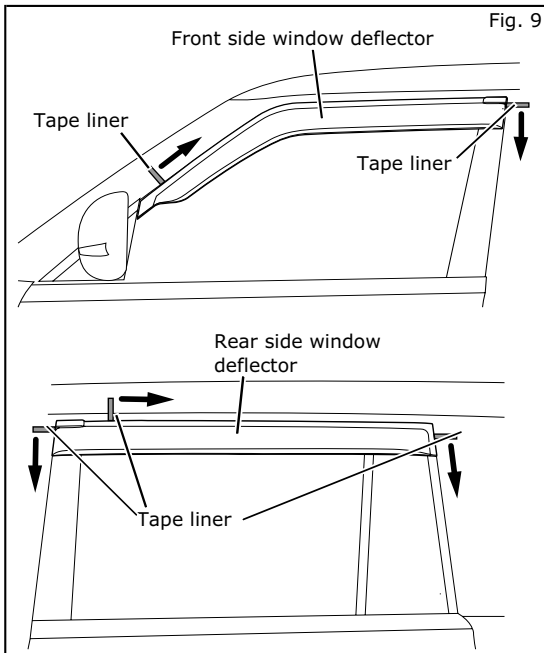

- l) Remove the tape liners and apply at least 15lbs. of pressure to the front and rear side window deflectors to ensure that the front and rear side window deflectors are attached. See Fig. 9.
- m) Open and close the window to confirm that the windows are functioning properly.